

TECHNICAL DATA : SMV 10-600 B

LIFTING DATA		
Lifting capacity / Load center (up to 7000 mm / standard mast)	kg / mm	10000 / 600
Lifting speed, unloaded / at rated load	m/s	0,50 / 0,45
Lowering speed, unloaded / at rated load	m/s	0,40 / 0,40
DRIVING DATA		
Drive speed forward, unloaded / at rated load	km/h	30 / 30
Drive speed reverse, unloaded / at rated load	km/h	30 / 30
Incline (driving ability) at rated load at 0 km/h/at 2 km/h	%	44 / 35
Towing (power ability) at rated load at 0 km/h/at 2 km/h	kN	108 / 86
SERVICE WEIGHT / AXLE PRESSURE		
Service weight	kg	14800
Axle pressure front, unloaded / at rated load	kg	7900 / 22600
Axle pressure rear, unloaded / at rated load	kg	6900 / 2200
ENGINE (electronic controlled)		
Engine make / model name		Volvo TAD-620-VE
Emission approval EU / US		St II / Tier 2
Monitoring / emission controlled / CanBus		Yes / yes / yes
Fuel / type of engine / intercooler		Diesel/4-stroke/ yes
Power ISO 3046 / at speed	kW / rpm	147 / 2300
Torque ISO 3046 / at speed	Nm / rpm	700 / 1500
Displacement / No. of cylinders / type	L / /	5,7 / 6-cyl / Inline
Fuel consumption, normal driving	L/h	6 – 8
Alternator, type/power	W / Amp	AC / 1540 / 55
Starting battery, voltage/capacity	V / Ah	2 x 12 / 88
TRANSMISSION (electronic controlled)		
Transmission make / model name		Dana TE-17300
Monitoring / reverse protection / CanBus		Yes / yes / yes
Clutch, type		Torque converter
Transmission type / type of shift gear		Softshift – Powershift / Automatic
No. of gears, forward/reverse		3 / 3
DRIVE AXLE & STEER SYSTEM		
Drive axle make / model name		Kessler D81
Drive axle type / drive axle width	/ mm	Differential + hub reduction / 2500
Service brake system, type / affected wheels		Oil cooled Wet Disc Brakes / drive wheels
Parking brake system, type / affected wheels		Dry disc brake / spring release / drive wheels
STEER AXLE & STEER SYSTEM		
Steer axle make / type		Konecranes / double acting single cylinder
Steering system		Hydraulic servo assisted / power steering
WHEELS		
Number of wheels, front+rear / Type (*driven)		4*+2 / pneumatic
Tire pressure front / rear	MPa	0,9 / 0,9
Tire dimensions (Ply rating) front / rear	Inch (No)	11.00 x 20" (PR 20) / 11.00 x 20" (PR 20)
Rim dimension front / rear	Inch	8.00 x 20" / 8.00 x 20"
HYDRAULIC SYSTEM		
Hydraulic pump make / model name		Parker & Hannifin / P2-series
Hydraulic system / pump type		Load sensing system / variable piston pump
Power-on-demand / Low energy		Yes / yes
Hydraulic oil pressure mast	MPa	22
TANK VOLUMES		
Diesel tank volume	L	131
Hydraulic tank volume	L	152
LIFTING EQUIPMENT		
Lift mast make / model		Konecranes / Duplex standard
Lift mast type / design		2-stage / free visibility
Fork carriage make / model		Konecranes / integral double forks
Fork carriage type		Hydraulic side shift & fork positioning
OTHERS		
Noise level (inside Cab / Lm) DIN 45635	dB(A)	68
Noise level (inside Cab/ LpAZ) EN 12053	dB(A)	72
Noise level (outside at 7 m/ Lwa) 2000/14/EC	dB(A)	109
NORMS & STANDARDS		
Machine Directive in Europe	98 / 37 EC	Yes
Stability of Industrial Trucks	ISO 1074	Yes
Safety of Industrial Trucks	EN 1551	Yes

TECHNICAL DATA

SMV 10-600 B

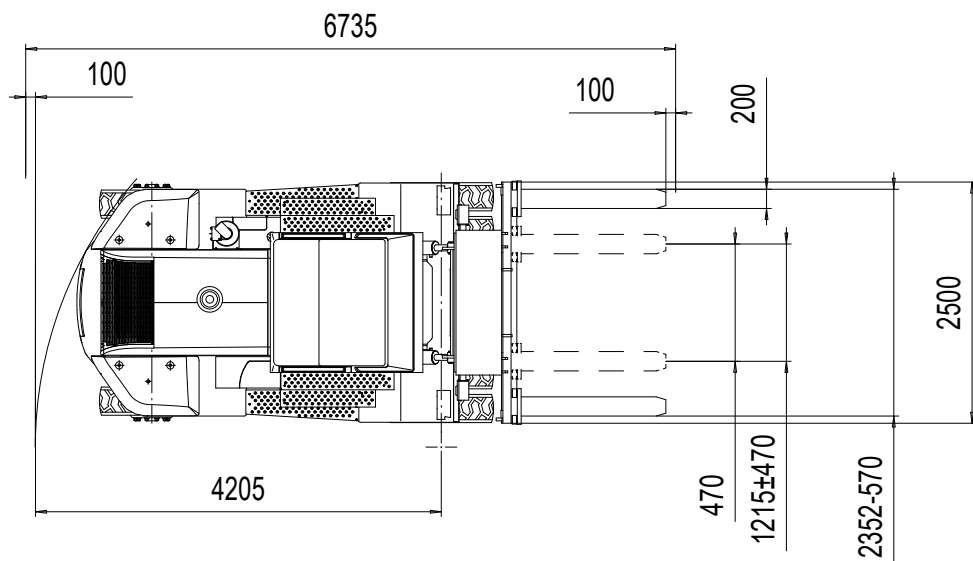
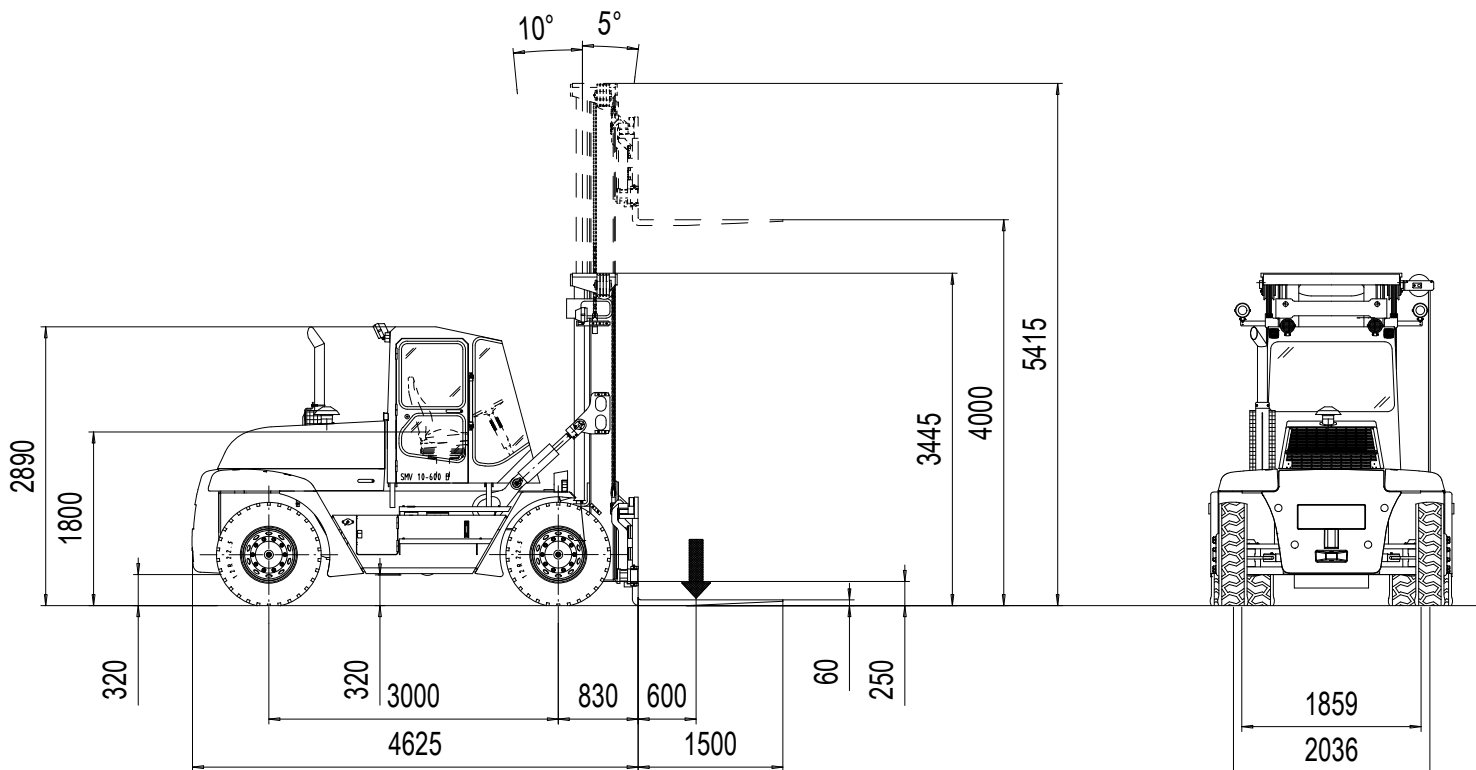

SMV 10-600B

